

Braille Display Systems for Blind People with Haptic Belt

M.N. Kamarudin^{1,2*}, M.Y.A. Aboali^{1,2}, H.N.M. Shah^{1,2}, M.H. Hairi^{1,2}, S.M. Rozali³, M.S.M. Aras^{1,2}

¹Center for Robotics and Industrial Automation (CeRIA),

²Fakulti Kejuruteraan Elektrik,

³Fakulti Teknologi Kejuruteraan Elektrik dan Elektronik,
Universiti Teknikal Malaysia Melaka (UTeM), Hang Tuah Jaya,
76100 Durian Tunggal, Melaka, Malaysia

*corresponding authors: nizamkamarudin@utem.edu.my

Abstract— This manuscript addresses the development of a microcontroller-based braille display system. Recently, tactile display devices use technologies such as electric motors, piezoelectric, and solenoids as actuators. Nevertheless, the device is seeming to be bulky, inflexible, and far from soft actuation. Thus, the project in this manuscript portrays the development of a new design by using Micro servomotors and embedded soft-computing algorithms. The system consists of a haptic belt and a sensing unit. The sensing part of a Braille cell is designed to be wearable on arm. The methodology to reach the outcomes involving the ATmega328P microcontroller in the Arduino board, Tower Pro SG51R micro servo, and the LV-MaxSonar-EZ1 ultrasonic sensor. These apparatuses are lumped in a Braille Display System with a Haptic Belt. The performance and functionality of the system are evaluated based on its ability to detect obstacles from four different locations by means of ultra-sonic sensors. The sensors actuate the servomotors to notice the blind. The system works well around 0.5 meters radius. The boundedness of the system radius is acceptable to secure ample time for the scanning process. The responses of the sensors upon various obstacles are presented in this manuscript with a thorough analysis.

Keywords— Braille; Haptic; Microcontroller; ultrasonic sensors; servomotors

I. INTRODUCTION

Worldwide, there are around 285 million considered visually impaired people, 39 million are blind, and 246 have low vision. Most of the world's visually impaired (90%) are living in developing countries [1]. According to the International Classification of Diseases-10 (Update and Revision 2006), there are four levels of visual function: blindness, and severe visual impairment, normal vision and moderate visual impairment [2].

For blind people, hearing, and touching become the first and second major senses respectively. There are many devices used to help blinds through hearing sense. However, it has demonstrated that 8 hours of 90db sound can cause damage to the ears, and 1 minute of 110 dB can cause hearing damage [2]. Recent studies [3, 4] have shown that a 20-30 minute listening to music, speech and sound activity causes degradation to human sensors information registration, and decreases the human capacity to perform tasks and affects the posture. As such, for the blind, touch becomes the primary input for the receipt of non-audible physical information. For this motive, wide ranges of technologies have been developed for tactile devices from traditional actuation technologies such as piezoelectric ceramic [5], electromagnetic coils [6]; shape memory alloys (SMAs) [7], electroactive polymers (EAPs) [8], electrorheological (ER) fluids [9] and air-bone ultrasound Pneumatics[10].

Article history: Manuscript received 28 August 2020; received in revised form 30 September 2020; Accepted 30 September 2020.

In all technologies mentioned in the literature and articles therein, they are still far from having slim and portable tactile devices especially when they are going to be wearable devices on any part of the human body. Some of the reasons are; it brings some difficulties in the construction of wearable devices such as complex driving electronics. According to the Royal National Institute for the Blind in the UK [11], millions of people are blind or have sight problems. 65% of them are children and elders over 65 years of age. These groups of people have a diverse range of abilities. As such, it is hard to draw a simple profile or stereotype for them. The individual variability of physical, sensory and cognitive functions is different. Thus, these factors mean that careful consideration is required to design effective user-driving electronics for these important and diverse groups. Therefore, the purpose of this project is to emphasize the simplicity of driving electronics.

Besides, the inefficient use of power and limitation of mobility are some of the disadvantages for the technologies aforementioned. As well as, a blind is faced with the unavoidable problem of the high cost.

A *tactile display for the fingers*, which is small enough to wrap around patient fingers like a Band-Aid has been developed by Korean and US researchers [12]. The advantage of a wearable tactile display compared to a *normal tactile display* is that they are flexible and small in size. However, when the normal device is applied to a non-flat surface like human skin, it is impossible to stimulate the whole skin through its shape. On the other hand, the wearable *Finger-Braille Interfaces* are user-friendly [13]. However, they cover the palm or the fingertip, which has the highest tactile sensitivity, where the frequency is approximately 116 Hz and weighing around 15g [14]. Thus, both devices have small size and high sensitivity, but they have shortcomings in stimulating the whole skin through their shapes.

A tactile device for the hand conveys information using intermittent alert like signals to provide the accuracy of information.

Then, blind people can easily understand the information interface or read by touching. However, this kind of devices is bulky and heavy [15]. Besides, shoe-Integrated tactile display [16], which is a tactile display, which enables users to obtain information through the sense of touch of their feet. The system is composed of flexible matrices of optoelectronic sensors covered by a soft silicone cover. This sensing system is completely modular, and it can cover areas of any sizes and shapes, and measure differential pressure ranges [17, 18].

Based on the literature and article therein, it can be concluded that most of the available wearable devices have identical operation principle by scanning the environment (using different technologies) and display the information gathered to other senses with different structures and features. The first group of devices is small in size. However, they share the shortcomings of the lack of skin stimulation through shapes. While the second group has large, but they can stimulate the whole skin through their shapes [19, 20].

II. METHODOLOGY

The methodology to develop a Braille Display System consists of 2 phases. In the first phase, application software for the system is developed using ATmega328P in the Arduino Uno microcontroller. The specification for the ATmega328P microcontroller circuitry is tabulated in Table I [21].

TABLE I
SPECIFICATIONS FOR ATMEGA328P CIRCUITRY

ATmega328P circuitry	Rating values
<i>Operating Voltage</i>	5V
<i>Input Voltage</i>	7 - 12V
<i>Input Voltage (limit)</i>	6 - 20 V
<i>Digital I/O Pins</i>	14
<i>PWM Digital I/O Pins</i>	6
<i>Analog Input Pins</i>	6
<i>DC Current per I/O Pin</i>	20mA
<i>DC Current for 3.3V Pin</i>	50mA
<i>Flash Memory</i>	32KB
<i>SRAM</i>	2KB
<i>EEPROM</i>	1KB
<i>Clock speed</i>	16MHz

The application program receives the signals from the sensors to actuates the desired dots to deliver the commands to the blind arm. The hardware design has two parts. The actuator part consists of four rubber points and actuated by two micro servo motors. Two points being attached to one motor and these points are actuated to give the demanded instructions to the blind person.

The sensing part of a Braille is wearable on the waist and receive an input signal from a microcontroller that is connected to four ultrasonic sensors. These sensors can detect an obstacle between 0 to 5 meters. Furthermore, the sensing system is used to detect any obstacle within a minimum distance of 0.1 meters to a maximum distance of 0.5 meters.

A. Micro Servomotor

The selected micro servomotor in this project is called a *Tower Pro SG51R micro servo* shown in Fig. 1. This type of servomotors can meet the requirement of having a small and lightweight for the overall system. Table II shows the specification of the micro servo motors.



Fig. 1. SG51R Micro servo

TABLE II: SPECIFICATION OF SG51R SERVO

Specification	Values
Size	22.9x11.4x22 mm
Weight	5g
Speed	@4.8V: 0.10 sec/60
Torque	@4.8V: 0.7 kg-cm
Working Temp	0C~55C

B. Cell Design

The actuation device has four points that are combined on one cell. The configuration is

illustrated in Fig. 2. They behave as the medium of instruction to deliver the information to the skin of the blind person. By using four points on one cell rather than six points, it is enough to deliver the required instructions to the blind arm. Eleven characters are needed to be received by the blind person in each character. There are four dots in rectangular of 2 rows and 2 columns



Fig. 2. Actuation Cell

C. Braille Commands

In the program and hardware implementation, one cell with four dots is going to be used. The cell gives the commands to the blind when facing any obstacle on his/her way. The commands are shown in Fig. 3. Table III describes the commands in detail.

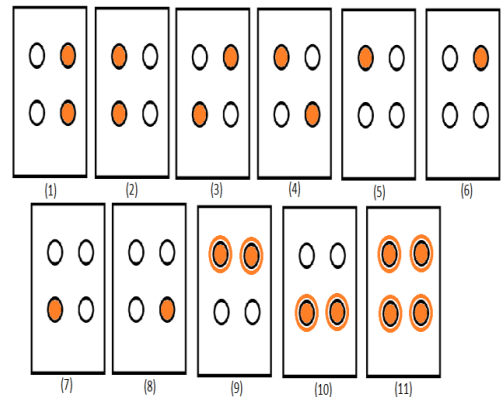

Fig. 3. Combination of the commands

TABLE III: COMMANDS COMBINATION

Commands	Comments
LEFT (1)	For an obstacle on the right-hand side, two right points will be activated.
RIGHT (2)	For an obstacle on the left-hand side, two left points will be activated.

UP-LEFT (5)	For an obstacle at the backside, The upper left point will be activated.
UP-RIGHT (6)	For an obstacle up and an obstacle at right. The upper right point will be activated.
DOWN-LEFT (7)	For an obstacle down and left. The lower left point will be activated.
DOWN-RIGHT (8)	For an obstacle down and right. The lower right point will be activated.
FRONT (9)	For an obstacle in front. The two upper points will be activated changeably
UP-DOWN (10)	For an obstacle up and down. The two lower points will be activated changeably
LEFT-RIGHT (11)	For an obstacle up, right, left and down at the same time. The whole four points will be activated changeably

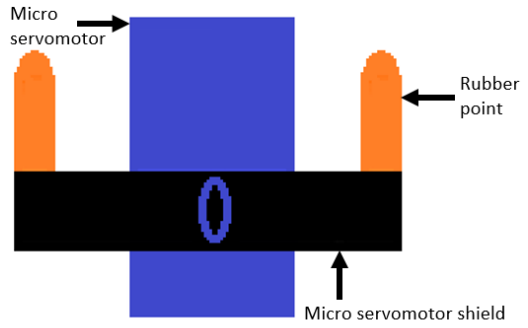

Fig. 5. The point on the servo motor shaft

D. Polystyrene Frame and Points Design

Placing the actuators in the system requires a judicious choice of frame. The frame that is used in the design is a frame made of polystyrene materials that can meet the requirement of being light, cheap, and can protect the skin of the blind person from being affected by the temperature due to the continuous motion of the servomotors and the points attached to them. The points will be activated based on input to the system from the sensing elements. Each of the dots will be made from rubber placed in the hole on the polystyrene body as depicted in Fig. 4.



Fig. 4. Dot between boundaries

E. Point Actuating

Servomotors are used as the system actuator. Each servo motor will be used to control the action of two points of the cell. By using two servomotors, the motion of the four points can be controlled. The configuration is shown in Fig. 5. The points made from rubber and placed on the top of two ends of the plastic bar that is connected perpendicularly to the shaft of the servomotor.

Each of the dots is attached between rigid boundaries as shown in Fig. 6. The status of each dot will change only when commands sent from the microcontroller to achieve the required instructions.

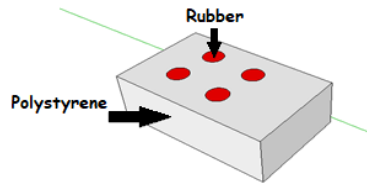

Fig. 6. Refreshable display cell

The frame of the cell is polystyrene where it is light to be worn on arm for a long time without causing pain to the skin. When any command is wanted to be performed, some of the dots are activated. Fig. 7 shows one of the commands for the right obstacle where some of the dots are in up-position while the others are in the downward position.

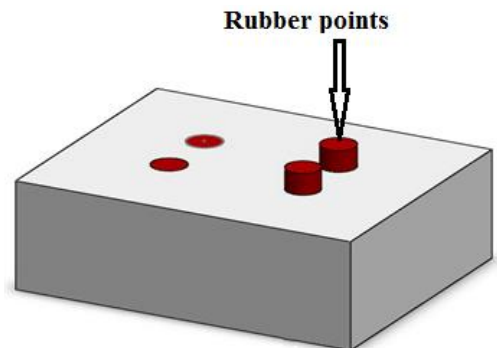

Fig. 7. Commands for right obstacle

According to [22] there are several stimulus parameters to be considered when determining the spot of the Braille display cell. These parameters are the location, spatial separation distance between braille display cell tractors, and frequency of tractors.

F. Ultrasonic sensor

The system is equipped with four ultrasonic sensors that are wearable around the waist. The purpose of such sensors is to develop smooth navigation of a visually impaired person. As such, the device is called a “Haptic Belt”, and can detect obstacles. Ultrasonic sensors transmit ultrasonic waves from the sensor head and receive the ultrasonic waves reflected from an object. By measuring the length of time from the transmission to the reception of the sonic wave, it detects the position of the object. In this project, an LV-MaxSonar-EZ1 sensor in Fig. 8 was selected.



Fig. 8. LV-MaxSonar-EZ1 sensor

G. Overall System Configuration

Fig. 9 shows the complete Braille Display System. The system consists of sensing element, processing, power supply, display cell and basic connections. Fig. 10 depicts the dimension of the casing assembly of the sensing system. In the operation wise, the system will check the surroundings of the blind using the sensing system. It senses any barriers on the way and sends the signal as an input to the microcontroller. The micro-controller is programmed in the Arduino software platform. It receives the signals from the sensors and generates instructions as an output signal. The microcontroller is placed inside the wearable around the waist device and the ultrasonic

sensors are attached properly to the device. The cell display receives the signals. Based on the signals, the desired dots are actuated to deliver the commands to the blind arm. The power supply is used to supply power to the microcontroller where it supplies the power to the sensing system and the display cell.

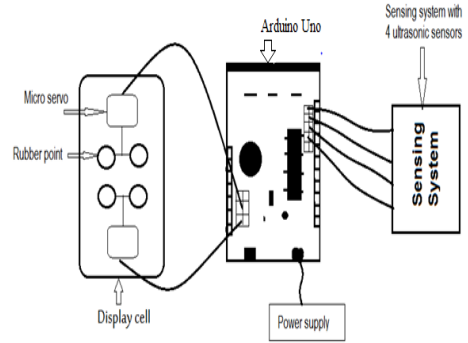

Fig. 9. Assembly of the overall system

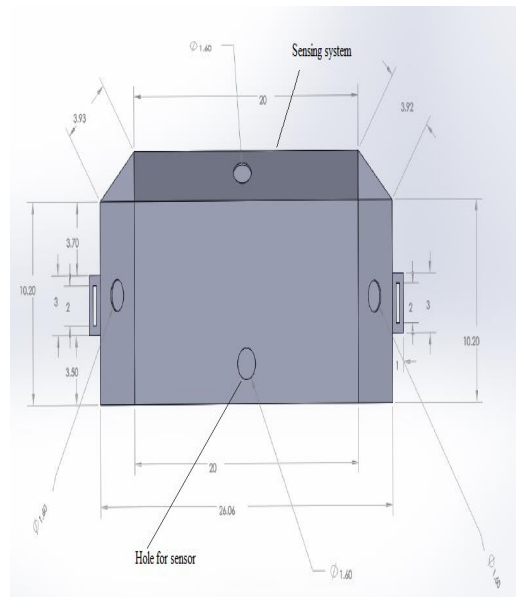

Fig. 10. Assembly of the sensing system.

H. System Prototype

The previous sub-section emphasizes the system configuration that consists of two main parts, a sensing system and an actuator system. Fig. 11 shows the whole part of the prototype. In the sensing system, there are four (4) ultrasonic sensors attached to the belt.

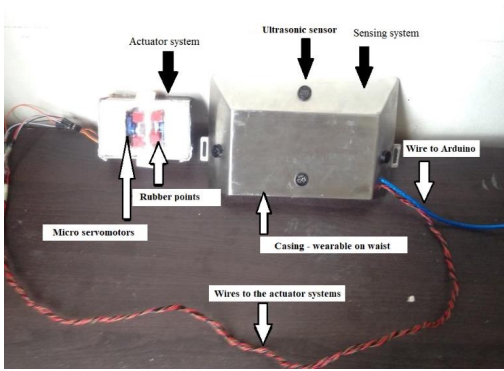

Fig. 11. Overall system

The sensors are located at the top, at the bottom and two sensors on the front of the belt. Among the two, one of them is placed on the right side and the other on the left side. Fig. 12 shows the ultrasonic sensors and their locations.

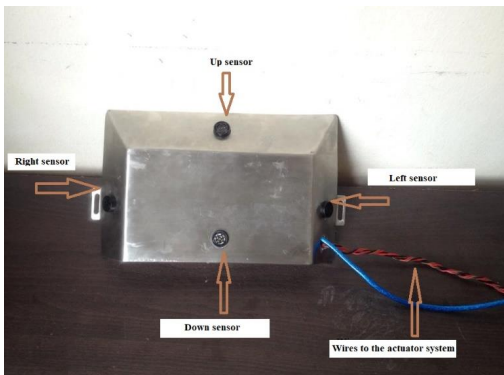

Fig. 12. Sensing system prototypes.

Two servomotors that are placed in the polystyrene frame power the actuators. Each of the motors can activate two rubber points placed in a piece of nylon that rotates to the desired position when the shaft of the motor rotates. Fig 13 shows the micro servo motor that has been embedded in the polystyrene frame with two rubbers.

The actuators connected to the skin of the arm of the blind person by rubber materials deliver the desired instruction concerning the obstacle. Fig. 14 illustrates the process of actuation due to the signals of the sensors.

The actuators are two servomotors the servomotors are given specific positions to be

activated due to the signals coming from the microcontroller. The servomotors can either be at 45°, 90° or 135°. When the servo at 45°, or 135° one of the rubber points will be activated. When the servo is at 90°, it does not actuate any of the points.

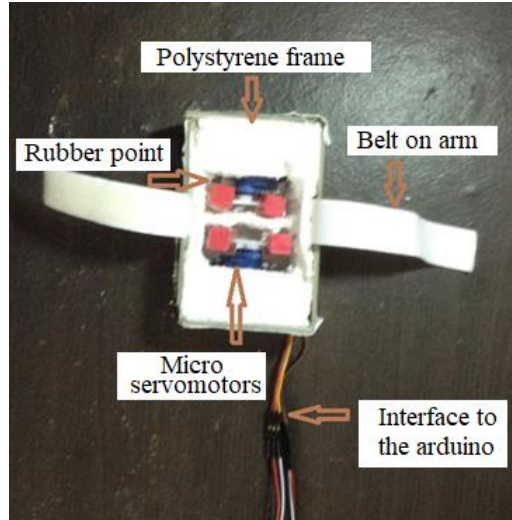

Fig. 13. Actuator system

As a result of the continuous scanning process when any of the points activated, it goes from 90° to either 45° or 135° depends on the signals coming from the microcontroller. However, when the two points of the actuators are deactivated the motor goes to 90° position and stay on it until any different signals arrive from the ultrasonic sensors through the microcontroller. Some of the commands depending on the actuation of one servomotor by switching rapidly between 45° and 135° of the same servomotor.

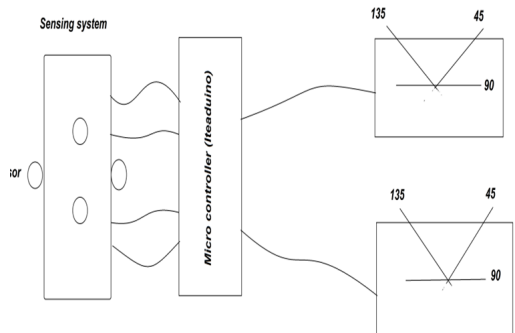

Fig. 14. Actuator action due to sensor signals

III. PROJECT OUTCOMES

To evaluate the system performance, the overall system has been examined and tested several times in the real environment with different obstacles such as chairs, various boxes, tables and doors. Plus, the operation of the system is also assessed for different distances.

When the system is powered up, the sensing system starts to scan the area around the person to detect any obstacles. The degree of freedoms for the sensors are bounded within upward, downward, right and left directions. Fig. 15 plots the output of the sensors without obstacles.

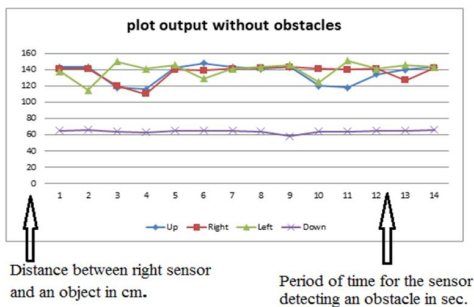

Fig. 15. Sensors output without obstacles

Fig. 16 plots the output with obstacles. It depicts the location of an object that is placed at almost 0.5 meters (50 cm) from the system. The object is placed on the floor. As such, the down-ward sensor successfully detects the object. The response of the sensor is shown in the response screen-shoot in Fig. 17. Whereas Fig. 18 shows the history of all sensors trajectory. Note that the response reading for the down-ward sensor in between 28 cm to 45 cm, which is less than 50 cm. This condition indicates that the object is at the bottom of the blind people.

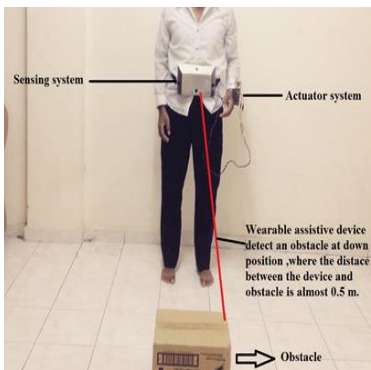

Fig. 16. Down sensor facing an obstacle

	up	right	left	down
	70	77	75	45
	70	76	75	45
	69	77	74	44
	69	77	75	43
	68	76	74	28
	68	76	74	28
	69	77	74	28
	68	75	74	28
	70	75	74	44
	70	76	75	44
	69	76	74	44
	69	77	75	45

Fig. 17. The random output of ultrasonic sensors during testing for the down sensor.

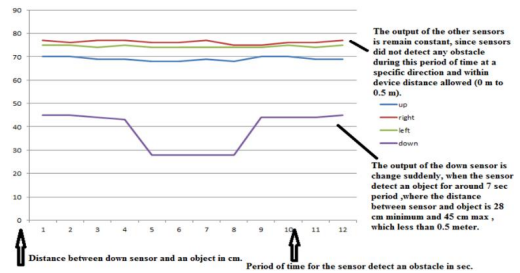

Fig. 18. Plot for down sensor facing the object

The testing is continued for 12 seconds when the object is placed at the right of the braille display system with a haptic belt (in Fig. 19), and to the left of the system (in Fig. 20). The object is paced no more than 50 cm from the system. The sensors readings are shown in the screenshot in Fig. 21 and Fig. 22 respectively. Fig. 23 and Fig. 24 show the history of the trajectory of the sensor that emphasizing the output of the front sensor and left sensor respectively.

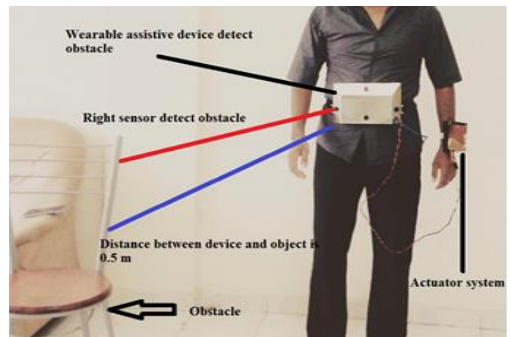

Fig. 19. Right sensor facing the object

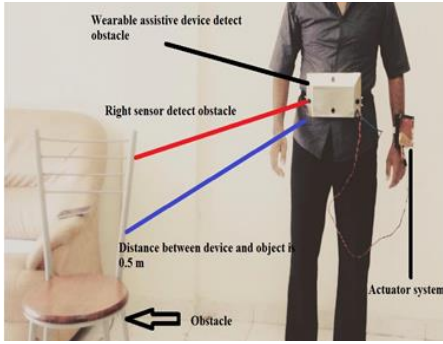

Fig. 20. Left sensor facing the object

up	right	left	down
70	43	75	78
70	43	75	78
69	42	74	77
69	40	75	78
68	37	74	78
68	27	74	77
69	27	74	78
68	24	74	78
70	24	74	78
70	27	75	77
69	42	74	77
69	42	75	77

Fig. 21. The random output of ultrasonic sensors during testing for the right sensor

up	right	left	down
64	71	41	78
66	71	41	78
66	70	40	77
65	70	40	78
65	71	27	78
66	71	27	77
66	69	26	78
66	69	26	78
66	70	35	78
65	70	36	77
65	69	39	77
65	70	42	77

Fig. 22. The random output of ultrasonic sensors during testing for the left sensor.

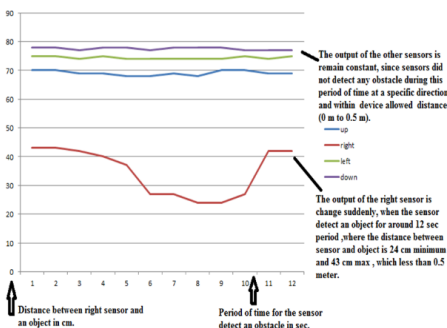

Fig. 23. Plot for right sensor facing object

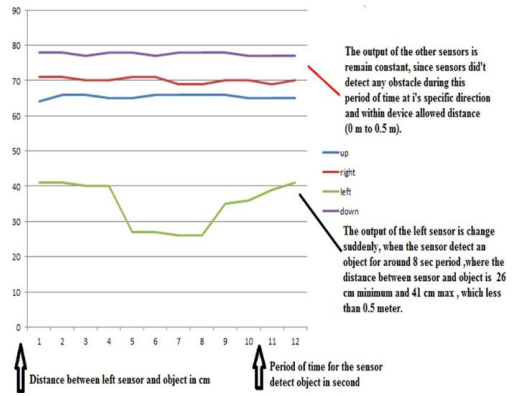

Fig. 24. Plot for left sensor facing object

IV. CONCLUSION

Based on the results, the braille display system with a haptic belt that has been reported in this manuscript functioned efficiently. In the experimental phase, all sensors able to detect objects cum obstacles and hence, actuate the servomotors accordingly. These servomotors are intact with the blind's arm. The motors articulate blind people the location of obstacles. Nevertheless, the system has shortcomings where it only works when the obstacles or objects are located within a 0.5-meter radius in 3-dimensional space. Propitiously, this limitation is acceptable as the movement of the blind is quite slower than the normal people. In this situation, the sensors have ample time to transmit the data before the blind people reach the objects. The time management and bill of materials are rather acceptable. The system can be considered as low cost as the availability of the components and apparatuses are tolerable.

ACKNOWLEDGEMENT

This project is developed by an undergraduate student taking the BEKU4792 and BEKU4894 courses. These courses are the requirement for the award of the Bachelor Degree in Electrical Engineering with honours in the Faculty of Electrical Engineering, Universiti Teknikal Malaysia Melaka. Special acknowledgement is

addressed to the Ministry of Higher Education Malaysia and all personnel who help to realize the project.

REFERENCES

- [1] WHO, Blindness and vision impairment. *Newsroom World Health Organization*, October 2019.
- [2] Häkkinen, J., Vuori, T., & Puhakka, M. Postural stability and sickness symptoms after HMD use. *In Proceedings of IEEE International Conference on Systems, Man and Cybernetics*, pp.147-152, October 2002.
- [3] Alexandra Filova, Jana Jurkovicova, Katarina Hirosova, Diana Vondrova, Barbora Filova, Martin Samohyl, Jana Babjakova, Juraj Stofko and Lubica Argalasova, Social Noise Exposure in a Sample of Slovak University Students, *International Journal of Environmental Research and Public Health*, vol. 17(1), pp. 1-12, 2020.
- [4] Roederer, Juan. Music and the evolution of human brain function. Music that works: *Contributions of biology, neurophysiology, psychology, sociology, medicine and musicology*, pp.195-210, 2010.
- [5] Ramiro Velazquez, Hermes Hernandez and Enrique Preza. A portable piezoelectric tactile terminal for Braille readers, *Applied Bionics and Biomechanics*, vol.9, pp. 45–60, 2012.
- [6] S. Magdaleno-Adame, J.C. Olivares-Galvan, E. Campero-Littlewood, R. Escarela-Perez, E. Blanco-Brisset. Coil Systems to Generate Uniform Magnetic Field Volumes. *Proceedings of the COMSOL Conference, Boston, 8 October 2010*.
- [7] Velázquez Ramiro, Pissaloux Edwige and Wiertlewski Michael, A compact tactile display for the blind with shape memory alloys, *in Proceedings IEEE International Conference on Robotics and Automation*, pp.3905-3910, June 2006.
- [8] Yoseph Bar-Cohen, Electroactive polymers for refreshable Braille displays, *SPIENewsroom*, pp.1-3, January 2009
- [9] Luning Xua, Junbiao Liub and Li Han. A Matrix of Valves based on Electro-Rheological Fluid and Its Application on Multi-Line Braille Displayer. *Advanced Materials Research Vol. 378-379*, pp.543-548, 2012
- [10] Hossain, E. Development of Navigation Aid for Visually Impaired Person. *Gombak: IIUM. Malaysia*, 2010.
- [11] Royal National Institute for the Blind official website. <https://councilfordisabledchildren.org.uk/>
- [12] Christian Antfolk, Christian Balkenius, Göran Lundborg. A Tactile Display System for Hand Prostheses to Discriminate Pressure and Individual Finger Localization. *Journal of Medical and Biological Engineering*, vol. 30(6), pp.355-360, 2010
- [13] Y. Matsuda. Emotion Teaching Interfaces Using Emoticons and Emojis for Finger Braille Emotion Teaching System. *Journal of Physics*, Vol. 1229, Pp.12-80, 2019.
- [14] Schmidt Marcelo, Metzger Luiz, Mortimer Robert and Ramirez A.R.G. New user interface using a single Braille cell approach. *Informática na educação: teoria & prática*, Vol. 20(2), pp.157-168, 2017.
- [15] Thekla Stefanou, Greg Chance, Tareq Assaf and Sanja Dogramadzi. Tactile Signatures and Hand Motion Intent Recognition for Wearable Assistive Devices. *Frontiers in Robotics and AI*, Vol. 6 pp. 1-17, 2019.
- [16] Qianli Xu, Tian Gan, Shue Ching Chia, Liyuan Li, Phyo Kyaw Kyaw. Design and Evaluation of Vibrating Footwear for Navigation Assistance to Visually Impaired People. *IEEE International Conference on Internet of Things (iThings) and IEEE Smart Data (SmartData)*, Pp.305-310, 2016
- [17] Ramiro Velazquez, J. Vardona, Omar Bazan. Wearable Electronic Tactile Display for the Foot. *Mechatronics and Control Systems Lab., Panamericana University*, pp.180-184, 2013.
- [18] Ramiro Velázquez, Edwige Pissaloux. Tactile Displays in Human-Machine Interaction: Four Case Studies. *The International Journal of Virtual Reality*, Vol.7(2), pp:51-58, 2008.
- [19] Velázquez, R. Wearable assistive devices for the blind. *Wearable and Autonomos Biomedical Devices and Systems for Smart Environment*, pp.331-349, 2010.
- [20] Koo, I. M., Jung, K., Koo, J. C., Nam, J. D., Lee, Y. K., & Choi, H. R. Development of soft-actuator-based wearable tactile display. *IEEE Transactions on Robotics*, Vol.24(3), pp.549-558, 2008.

- [21] Muhammad Nizam Kamarudin, Sahazati Md. Rozali, Mohd Hendra Hairi, Farhan Hanaffi, Mohd Shahrieel Mohd Aras, Mohd Khairi Mohd Zambri. Realization of Real-Time Hardware-in-the-Loop for a Liquid Level with Open-loop Ziegler Nichols Technique. *International Journal of Electrical Engineering and Applied Sciences*, Vol.1(2), pp.47-51, 2018
- [22] Choi, H. R., Ryew, S. M., Jung, K. M., Kim, H. M., Jeon, J. W., Nam, J. D., & Tanie, K. Soft actuator for robotic applications based on dielectric elastomer: quasi-static analysis. *IEEE International Conference on Robotics and Automation ICRA'02*, Vol.3, pp.3212-3217, 2002.